

HA790 55" 46" 40" 32"



- 3D
- Smart Hub / Smart Widget solution compatibility
- Soft AP
- AllShare (DLNA)
- Slim LED
- REACH & SIRCH
- Built-in Wi-fi
- HBB TV
- DVB-T / C / S2
- Soundbar compatibility
- Multi-code remote control

HA590 46" 40" 32"



- Smart Hub / Smart Widget solution compatibility
- Soft AP
- AllShare (DLNA)
- HBB TV
- DVB-T / C / S2
- Soundbar compatibility
- Swivel stand 20°/60°/90°
- Multi-code remote control

To learn more about Samsung Hospitality TVs, please visit www.samsung.com/hospitality

Samsung Electronics Co., Ltd. Head Office (Suwon, Korea) 416, Maetan-3 Dong, Yeongtong-Gu, Suwon City, Gyeonggi-Do, 443-742, Korea



The innovative LED technology with Samsung Smart Widget Solution

The Samsung LED Series 79/59 has raised the standard for premium Hospitality Displays. Combining the latest in LED technology with an elegant eye-catching design, it will become the focal point of your rooms.

With the image enhancing Slim LED technology and the latest in 3D imaging technology, the Series 79 delivers the highest image quality while providing your guests with an immersive 3D entertainment experience. Smart Hub and Smart Widget solution offer your guests an extra level of engagement and flexibility.

Series **79** **59**



Full HD 3D experience

Cutting edge TV technology with Samsung Hospitality Displays. It's a TV that will satisfy guests looking for the best picture quality, along with an utterly absorbing 3D viewing experience. And because Samsung is at the forefront of 3D technology, viewers will experience the future of home entertainment from the comfort of their room. Available in various screen sizes, Samsung's Hospitality Displays produce full HD 3D images that are amazingly realistic and bursting with vivid colour. We achieve the very highest standard in 3D imaging through our intuitive 3D HyperReal Engine. This technology controls the colour, contrast, 3D effects and motion for mind-blowing results. Images are so life-like and crystal-clear that they ensure that the viewing experience is not only captivating, but also comfortable. Enjoying 2D images in 3D is a brilliant reality with Samsung Hospitality Displays. At the push of a button Samsung 3D Converter transforms your favourite TV programmes or movies with amazing 3D-depth. It will reinvent your favourite 2D content.

* 3D feature is only available for Series 79.



Customised solutions with Samsung Smart Widget

The Samsung Hospitality Displays Smart Widget is the premium set top box integrated solution for the hospitality market, which supports customisable content, editing platform and Smart Hub application based on IP infra:

- The set top box to enable premium interactive services and remote TV control is integrated with the unit so there is no need to install and maintain an external STB – saving you money.
- Our CMS (Content Management Solution) is easy-to-use, enabling you to effortlessly select templates, edit text, images and video clips to compose the content you wish to provide. It supports a highly flexible and sophisticated UI allowing you to deliver a hotel specific or customised guest experience.
- Our user interface is highly flexible allowing you to provide a customised channel list, welcome message or instant message per guest or group of guests.
- Through the CMS you can edit multicast channel and update TV firmware
- Your guests can experience a wide variety of web based applications through the Samsung Smart Hub Smart TV platform such as social networking and entertainment packages making them truly feel at home.

The Smart Widget Solution is good news for your guests and good news for your business thanks to the ability to deliver a better guest experience while achieving the lowest total cost of ownership.

Increased wireless connectivity through AllShare

Through Samsung Hospitality Displays with AllShare, powered by DLNA, content including movies, photos and music in DLNA enabled personal devices can be seamlessly shared between the device and the TV, even wirelessly. That means personal content can be enjoyed on the vivid larger screen, helping to enhance the overall entertainment experience.

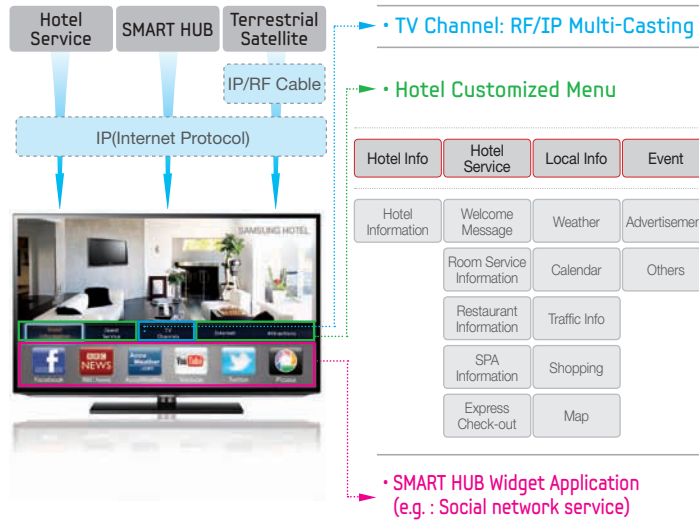

Slim LED

Superior TVs in your rooms can provide a valuable part of a quality hotel experience. With the eye-catching yet elegant design of our slim LED Hospitality Displays, you can elevate your guest's viewing pleasure like never before. Created specifically for premium hotels, the sophisticated design of our TVs will become the focal point of your rooms.



Energy saving of up to 40%

Samsung's range of energy-efficient LED TVs is setting the standard when it comes to saving energy and reducing costs. Samsung Hospitality Displays are a cost effective business solution due to their energy-efficient features and ability to decrease maintenance and management oversight. Our Hospitality Displays offer a number of energy efficient advantages that are designed to lower power usage and your overall energy bill. Samsung LED technology cuts energy consumption by nearly 50% compared with Energy STAR 4.0. This means a 56" Samsung LED TV consumes the same amount of energy as a conventional 32" LCD TV. What's more, LED TVs from Samsung are durable, offering a long lifetime without loss of picture quality. Samsung Displays are also built with less harmful materials, so that the manufacturing and recycling processes are much more efficient and friendlier to the environment.

REACH

(Remote Enhanced Active Control for Hospitality)

REACH is the Samsung Hospitality Display's integrated set top box solution. It provides a simple user interface and editing tool that allows content such as EPG (program guide), property logo, hotel information and images to be updated either remotely through the advanced SIRCH device or through USB cloning on a room by room basis. Therefore, without installing IP infra, it is possible to use this solution through the existing coax cable, without the requirement to install a separate STB - saving you money.

SIRCH

(Samsung Interactive Remote Control for Hospitality)

Every manager or owner of a substantially sized hotel wants to manage their estate of TVs without visiting every room and adjusting every set individually. Our intelligent SIRCH (Samsung Interactive Remote Control for Hospitality) solution can make your life so much easier by managing your TVs from one central location via air broadcast. You can configure settings, like setting up initial and maximum volumes as well as editing and updating channel lists universally and remotely. Important firmware upgrades can also be made the same way, eliminating interruption or service limitation, and providing a better experience for your guests. The advantages to you are varied. Remote control and management significantly reduces the cost of manually updating each set, saving time, resource, and a lot of legwork.

Stay connected with SoftAP

SoftAP is short for Software enabled Access Point. This "virtual" Wi-Fi feature is enabled by intelligent software that creates a wireless hotspot - or portable hotspot - that other wireless devices in the vicinity can jump onto and use. Samsung Hospitality Display supports Soft AP so you can set up a wireless IP environment and provide internet service without installing an access point providing further cost savings. Guests can easily connect personal devices to the TV and share content seamlessly leading to an improved user experience.

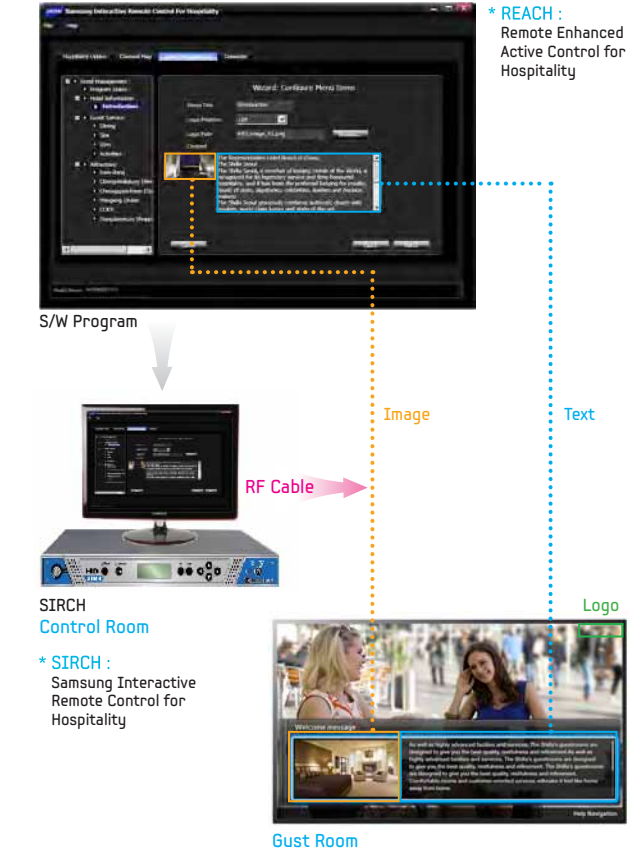

Built-in Wi-Fi

With Wi-Fi embedded in Samsung Hospitality Displays you don't need a LAN cable for internet service and you can offer your guests an extra level of engagement and flexibility.



Soundbar compatibility

Samsung Hospitality Displays enable Soundbar compatibility by supporting HDMI-CEC. By connecting the Soundbar to the Samsung Hospitality Display with a HDMI cable the TV audio settings and menu lock feature are automatically applied, so you don't have to set up the Soundbar separately and you can also prevent guests from changing the settings. With one single remote, guests can control both TV and Soundbar simultaneously. The Samsung wall-mountable Soundbar allows you to offer your guests a full 3D surround sound experience through one easy to install device that fits into the most prestigious environment and adds a touch of elegance to your rooms.



Wider broadcasting compatibility though built-in DVB-T/C/S2 Tuner

Channel hoppers are happiest when they are offered almost endless choice through their TV. Again, that's where we deliver. This digital television standard has been designed as a successor for the DVB-S system, and achieves a significantly better performance than its predecessor. The DVB-T/C/S2 tuner provides HD picture quality satellite broadcasting without the additional cost of installing head-end devices to convert to DVB-T/C. Historically it was very costly to deliver satellite channels to a TV that only had a DVB-S tuner. Now you can add many more local and international HD satellite channels directly to your rooms without worrying about the cost.

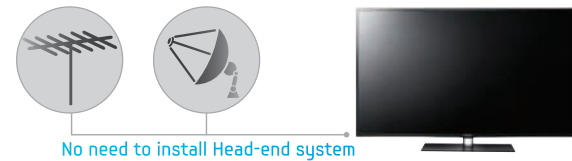

Multi-code remote up to 10 TVs

With the Samsung Hospitality Display TV's multi-code remote up to 10 TVs can be controlled individually in the same room. For application in gym and hospital environments this means guests can enjoy watching TV without annoying interference from other remote signals.

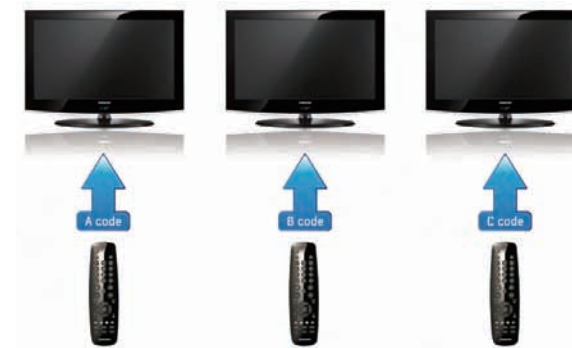

Swivel stand with optional stops

Samsung Hospitality Displays pedestal stand rotates 90 degrees in both directions with optional 20, 60 and 90 degree stops so wherever in the room your guests are they should have an excellent view of their TV.



Put your guests in control with My Channel

Whatever their country of origin or language, you can make your guests really feel at home with Samsung Hospitality Displays. Our My Channel has been designed for maximum convenience. It allows your guests to access channels according to their personal preference, by selecting their country and genre.

This way, guests can find and enjoy their desired channels quickly and efficiently. This offers a valuable timesaving benefit, as there is now no need to 'trawl' the menu looking for their favourite TV show or movie.



Management solution

• **USB cloning (for quick TV setting & upgrade)**

To help you work more efficiently, the innovative USB Cloning feature allows you to easily customise and then copy settings such as channels, picture, volume and logo display across your entire TV estate, saving you time from adjusting the settings on each individual box.

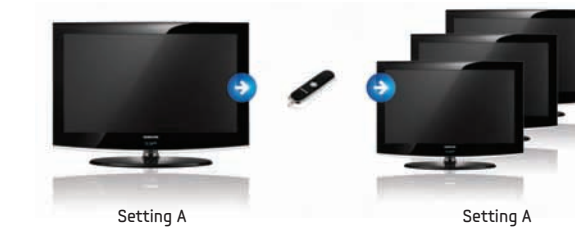

• **Channel manager**

Generate awareness and enhance your brand image through your logo display and welcome message to all guests. This can be displayed for an adjustable period of 3-7 seconds.

- Analog & digital channel mix & edit
- Channel bank (smoovie compatibility)
- Channel re-mapping

• **Welcome message and logo display**

To help you work more efficiently, the innovative USB Cloning feature allows you to easily customise and then copy settings such as channels, picture, volume and logo display across your entire TV estate, saving you time from adjusting the settings on each individual box.

• **Easy installation and setup**

Samsung Hospitality Displays include easy-to-follow, step-by-step onscreen instructions that guide you through the entire installation process.



Security solution

• **Anti-theft battery cover**

Replacing stolen batteries can become costly over time that's why Samsung Hospitality Display remotes were designed with a special battery cover that is screwed on.



• **Fire-resistant casing**

To help prevent fire damage to your Hospitality TV estate the casings for Samsung Hospitality Displays use a flame retardant material that is able to withstand extremely high temperatures and is also non-flammable to prevent any fire from spreading.

Energy efficiency solution

• **Energy saving mode**

With Samsung's Energy Saving Mode you can select from three pre-defined optimised settings that control the amount of energy the TVs use.

• **Music mode**

When a guest has connected an external device to the Samsung Hospitality Display to play music the panel backlight can be turned off thus decreasing the power consumption of the unit when in music mode.



Guest convenience

• **Remote jack pack compatible**

Through the Jack Pack your guests can connect and play various electronic devices from laptops to cameras to the TV.



• **Headphone output and headphone ID**

Samsung Hospitality Displays have a headphone socket to plug headphones in directly and the Headphone ID automatically detects the headphones. In a hotel or hospital environment you can extend the headphone cable to a bed of table.

• **External speaker output**

With the Samsung Hospitality Display, you can connect the sound to other parts of the room or for example to a bathroom speaker, so your guests can hear the TV wherever they are.

• **Auto sensing input**

Auto Sensing enables the Samsung Hospitality Display to automatically detect any compatible digital device that is connected to the TV via HDMI or USB without the user needing to adjust the mode.



• **Multimedia connectivity - USB2.0**

Guests can enjoy their own movies, music and images by simply plugging their USB into the Samsung Hospitality Display with no format limitation.

Dimension

HA790 55" 46" 40" 32"

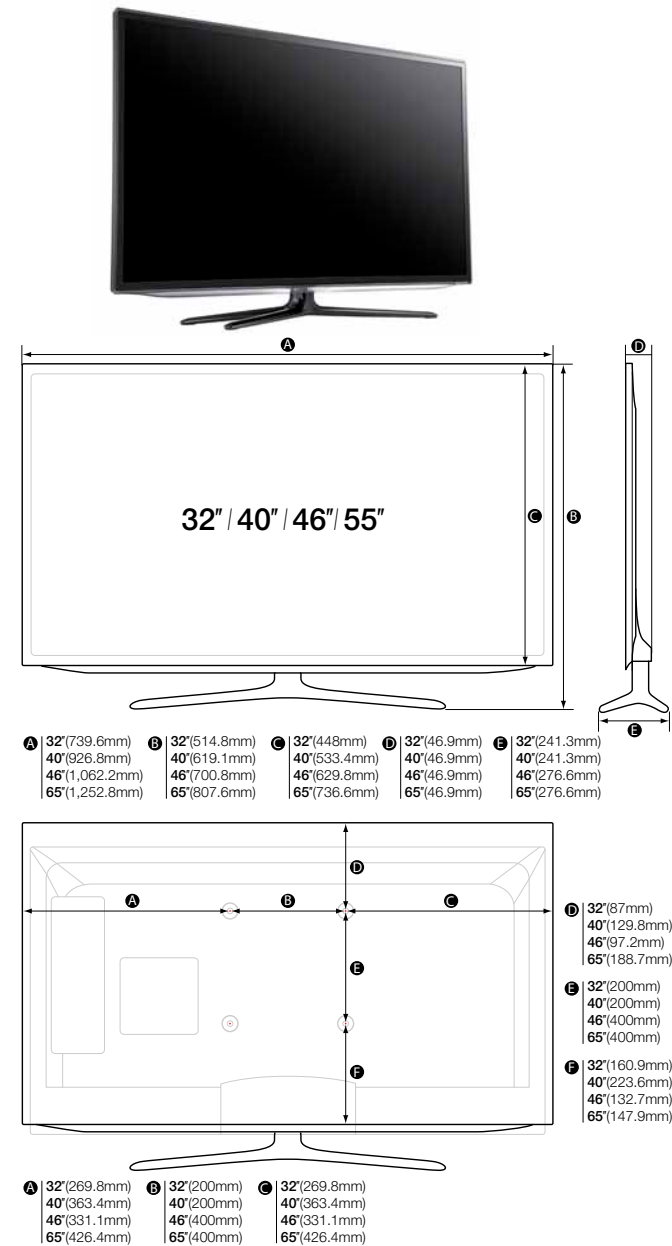

Specification

Model	32HA790	40HA790	46HA790	55HA790
Basic Info				
Model Name	HG32EA790MS	HG40EA790MS	HG46EA790MS	HG55EA790MS
Screen Size	32"	40"	46"	55"
Video				
Resolution	1,920 x 1,080	1,920 x 1,080	1,920 x 1,080	1,920 x 1,080
Response Time	TBD	TBD	TBD	TBD
Viewing angle (H/V)	TBD	TBD	TBD	TBD
Backlight	LED	LED	LED	LED
Dynamic Contrast Ratio	Mega Contrast	Mega Contrast	Mega Contrast	Mega Contrast
Brightness	TBD	TBD	TBD	TBD
Audio				
Output	10W x 2	10W x 2	10W x 2	10W x 2
Dolby Surround(SRS)	Dolby Digital Plus / Dolby Pulse SRS TheaterSound HD	Dolby Digital Plus / Dolby Pulse SRS TheaterSound HD	Dolby Digital Plus / Dolby Pulse SRS TheaterSound HD	Dolby Digital Plus / Dolby Pulse SRS TheaterSound HD
Feature				
Samsung SMART TV	Yes	Yes	Yes	Yes
Samsung 3D (2D ->3D)	Yes	Yes	Yes	Yes
Smart Phone Remote Support	Yes	Yes	Yes	Yes
AllShare(Powered by DLNA)	Yes	Yes	Yes	Yes
Wireless LAN Built-in	Yes	Yes	Yes	Yes
Teletext	Yes	Yes	Yes	Yes
HBB TV	Yes	Yes	Yes	Yes
ConnectShare™ (USB2.0)	Movie	Movie	Movie	Movie
AnyNet+ (HDMI-CEC)	Yes	Yes	Yes	Yes
Auto Channel Search	Yes	Yes	Yes	Yes
Auto Power Off (Auto TV On)	Yes	Yes	Yes	Yes
Auto Volume Leveller	Yes	Yes	Yes	Yes
Caption(Subtitle)	Yes	Yes	Yes	Yes
Clock & On/Off Timer	Yes	Yes	Yes	Yes
Sleep Timer	Yes	Yes	Yes	Yes
OSD Language	29 European Languages	29 European Languages	29 European Languages	29 European Languages
Input & Output				
RF In (Terrestrial/Cable input)	1	1	1	1
RF In (Satellite input)	1	1	1	1
RJ12 For External Control	1	1	1	1
RJ45	1	1	1	1
HDMI (Side/Rear)	1/2	1/2	1/2	1/2
USB (Side/Rear)	1/1	1/1	1/1	1/1
Component In(Y/Pb/Pr) (Side/Rear)	0/1	0/1	0/1	0/1
Composite In(AV) (Side/Rear)	0/1 (Common Use for Component Y)	0/1 (Common Use for Component Y)	0/1 (Common Use for Component Y)	0/1 (Common Use for Component Y)
Ethernet (LAN)	1	1	1	1
Headphone	1	1	1	1
Digital Audio Out(Optical)	1	1	1	1
Variable Audio Out	1	1	1	1
VOL-CTRL	1	1	1	1
RJP Jack (Remote Jack Pack)	1	1	1	1
PC In (D-sub)	1	1	1	1
PC Audio In (Mini Jack)	1	1	1	1
DVI Audio In (Mini Jack)	1 (Common Use for PC Audio In)	1 (Common Use for PC Audio In)	1 (Common Use for PC Audio In)	1 (Common Use for PC Audio In)
Scart	1	1	1	1
Hospitality Feature				
Smart Widget Solution(CMS)	Yes	Yes	Yes	Yes
Smart Widget Solution(H-browser)	Yes	Yes	Yes	Yes
Web Browser	Yes	Yes	Yes	Yes
REACH	Yes	Yes	Yes	Yes
SIRCH Compatibility	Yes	Yes	Yes	Yes
Hospitality Plug & Play (Easy Setup)	Yes	Yes	Yes	Yes
RJ12 / IR pass through	Yes	Yes	Yes	Yes
Music Mode (Input: PC/AV/Component)	Yes	Yes	Yes	Yes
My Channel	Yes	Yes	Yes	Yes
Jack Pack Compatibility	Yes	Yes	Yes	Yes
USB Cloning	Yes	Yes	Yes	Yes
Bathroom Speaker output	Yes	Yes	Yes	Yes
Logo Display with Time out Setting(BMP/Movie)	Yes	Yes	Yes	Yes
Welcome Message	Yes	Yes	Yes	Yes
Auto Source mode	Yes	Yes	Yes	Yes
Multi Code Remote	Yes	Yes	Yes	Yes
Screwed Remote Battery Cover	Yes	Yes	Yes	Yes
Alarm Key	Yes	Yes	Yes	Yes
Mixed channel list(DVB T/C/S2, Analog)	Yes	Yes	Yes	Yes
Smovie Compatibility	Yes	Yes	Yes	Yes
Soundbar Compatibility	Yes	Yes	Yes	Yes
Design				
Front Color	Black	Black	Black	Black
Stand Type	Quad	Quad	Quad	Quad
Swivel (Left/Right)	20°	20°	20°	20°
Dimension	Dimensions (WxHxD)mm With Stand	739.6*514.8*241.3	926.6*619.1*241.3	1062.2*700.8*227.6
	Dimensions (WxHxD)mm Without Stand	739.6*448.9	926.6*353.4*46.9	1252.2*326.6*46.9
VESA	Dimensions (mm)	200*200	200*200	400*400
Accessory	Screw Size	TBD	TBD	TBD
	Batteries(for Remote Control)	Yes	Yes	Yes
	RJ 12 Cable	Yes	Yes	Yes
	Power Cable	Yes	Yes	Yes
	Data Cable	Yes	Yes	Yes
	Installation manual(Quick guide)	Yes	Yes	Yes
System	DTV Reception	DVB-T/C/S2	DVB-T/C/S2	DVB-T/C/S2
	DSegC	Yes	Yes	Yes
Power	Power	TBD	TBD	TBD
	Power Consumption (Max) (Watts)	TBD	TBD	TBD
	Power Consumption (Stand-by) (Watts)	TBD	TBD	TBD
Security	Kensington Lock	Yes	Yes	Yes

* Please visit the website to verify detail specifications

Dimension

HA590 46" 40" 32"

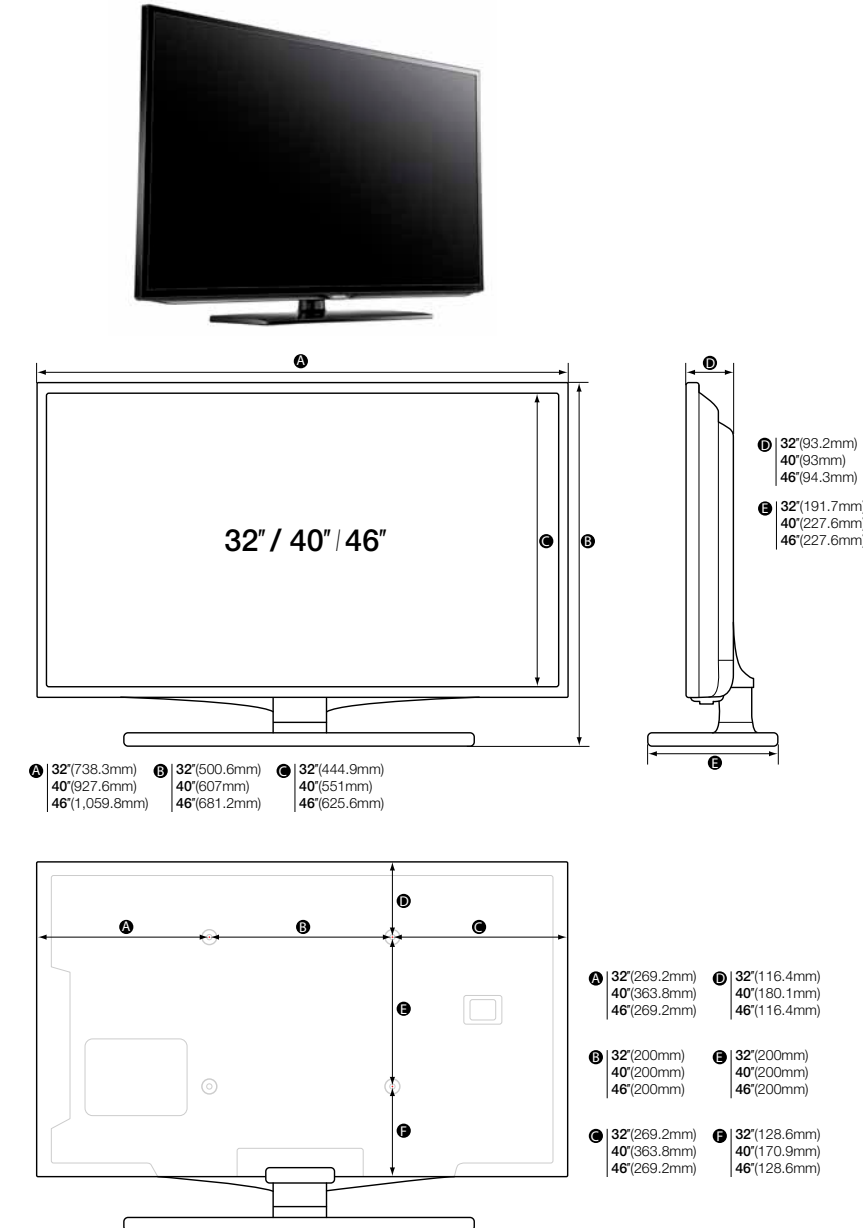

Specification

Model	32HA590	40HA590	46HA590
Basic Info			
Model Name	HG32EA590LS	HG40EA590LS	HG46EA590LS
Screen Size	32"	40"	46"
Video			
Resolution	1920 x 1080	1920 x 1080	1920 x 1080
Response Time	TBD	TBD	TBD
Viewing angle (H/V)	TBD	TBD	TBD
Backlight	LED	LED	LED
Dynamic Contrast Ratio	TBD	TBD	TBD
Brightness	TBD	TBD	TBD
Audio			
Output	10W x 2	10W x 2	10W x 2
Dolby Surround(SRS)	Dolby Digital Plus / Dolby Pulse SRS TheaterSound	Dolby Digital Plus / Dolby Pulse SRS TheaterSound	Dolby Digital Plus / Dolby Pulse SRS TheaterSound
Feature			
Samsung SMART TV	Yes	Yes	Yes
Samsung 3D (2D ->3D)	No	No	No
Smart Phone Remote Support	No	No	No
AllShare(Powered by DLNA)	Yes	Yes	Yes
Wireless LAN Built-in	Yes	Yes	Yes
Teletext	Yes	Yes	Yes
HBB TV	Yes	Yes	Yes
ConnectShare™ (USB2.0)	Movie	Movie	Movie
AnyNet+ (HDMI-CEC)	Yes	Yes	Yes
Auto Channel Search	Yes	Yes	Yes
Auto Power Off (Auto TV On)	Yes	Yes	Yes
Auto Volume Leveller	Yes	Yes	Yes
Caption(Subtitle)	Yes	Yes	Yes
Clock & On/Off Timer	Yes	Yes	Yes
Sleep Timer	Yes	Yes	Yes
OSD Language	29 European Languages	29 European Languages	29 European Languages
Input & Output			
RF In (Terrestrial/Cable input)	1	1	1
RF In (Satellite input)	1	1	1
RJ12 For External Control	1	1	1
RJ45	1	1	1
HDMI (Side/Rear)	1/2	1/2	1/2
USB (Side/Rear)	1/1	1/1	1/1
Component In(Y/Pb/Pr) (Side/Rear)	0/1	0/1	0/1
Composite In(AV) (Side/Rear)	0/1 (Common Use for Component Y)	0/1 (Common Use for Component Y)	0/1 (Common Use for Component Y)
Ethernet (LAN)	1	1	1
Headphone	1	1	1
Digital Audio Out(Optical)	1	1	1
Variable Audio Out	1	1	1
VOL-CTRL	1	1	1
RJP Jack (Remote Jack Pack)	1	1	1
PC In (D-sub)	1	1	1
PC Audio In (Mini Jack)	1	1	1
DVI Audio In (Mini Jack)	1 (Common Use for PC Audio In)	1 (Common Use for PC Audio In)	1 (Common Use for PC Audio In)
Scart	1	1	1
Hospitality Feature			
Smart Widget Solution(CMS)	Yes	Yes	Yes
Smart Widget Solution(H-browser)	Yes	Yes	Yes
Web Browser	Yes	Yes	Yes
REACH	Yes	Yes	Yes
SIRCH Compatibility	Yes	Yes	Yes
Hospitality Plug & Play (Easy Setup)	Yes	Yes	Yes
RJ12 / IR pass through	Yes	Yes	Yes
Music Mode (Input: PC/AV/Component)	Yes	Yes	Yes
My Channel	Yes	Yes	Yes
Jack Pack Compatibility	Yes	Yes	Yes
USB Cloning	Yes	Yes	Yes
Bathroom Speaker output	Yes	Yes	Yes
Logo Display with Time out Setting(BMP/Movie)	Yes	Yes	Yes
Welcome Message	Yes	Yes	Yes
Auto Source mode	Yes	Yes	Yes
Multi Code Remote	Yes	Yes	Yes
Screwed Remote Battery Cover	Yes	Yes	Yes
Alarm Key	Yes	Yes	Yes
Mixed channel list(DVB T/C/S2, Analog)	Yes	Yes	Yes
Smovie Compatibility	Yes	Yes	Yes
Soundbar Compatibility	Yes	Yes	Yes
Design			
Front Color	Black	Black	Black
Stand Type	Square	Square	Square
Swivel (Left/Right)	20°/60°/90°	20°/60°/90°	20°/60°/90°
Dimension	Dimensions (WxHxD)mm With Stand	738.3*500.6*191.7	927.6*551.0*227.6
	Dimensions (WxHxD)mm Without Stand	738.3*353.4*44.9	1059.9*381.2*227.6
VESA	Dimensions (mm)	200*200	400*400
Accessory	Screw Size	TBD	TBD
	Batteries(for Remote Control)	Yes	Yes
	RJ 12 Cable	Yes	Yes
	Power Cable	Yes	Yes
	Data Cable	Yes	Yes
	Installation manual(Quick guide)	Yes	Yes
System	DTV Reception	DVB-T/C/S2	DVB-T/C/S2
	DSegC	Yes	Yes
Power	Power	TBD	TBD
	Power Consumption (Max) (Watts)	TBD	TBD
	Power Consumption (Stand-by) (Watts)	TBD	TBD
Security	Kensington Lock	Yes	Yes

* Please visit the website to verify detail specifications