

Bar code

USER MANUAL

Read the manual carefully and ensure you have fully understood its contents before operating this device for the first time.



Declaration

Any content and service accessed through this device, while only intended for individual non-commercial use, shall be the property of the applicable third party and subject to protection by regulations and laws on copyright, patent, trademark and other intellectual property rights. No part of such content and service may be modified, duplicated, published, uploaded, distributed, translated, marketed, or used to make and distribute products derived from it without the prior permission of the content owner or service provider.

You acknowledge and agree explicitly that you will solely bear the risk associated with the use of this device, and further you will solely bear any risk related to satisfactory quality, performance and accuracy for any content and service accessed through this device. To the maximum extent permitted by applicable law, this device and any third party's content and service is provided as it is without any guarantee, express or implied.

Manufacturer hereby declare explicitly that Manufacturer shall not be held liable for any guarantee and conditions, express or implied, related to this device and any content and service, including but not limited to warranty on marketability, satisfactory quality, fitness for a particular purpose, accuracy, quiet use and non-violation of any third party's rights; to the maximum extent permitted by applicable law, Manufacturer gives no guarantee on the accuracy, validity, timeliness, legitimacy and completeness of any content or service provided through this device, or the fitness of such device, content or service for your particular requirement, or the protection from interruption and error during operation of such device, content or service; to the maximum extent permitted by applicable law, in any case, including fault or neglect, Manufacturer shall not be held liable for legal actions or indemnity obligation arising from any consequence as a result of or related to any information loaded in this device or use of such device, content or service by you or any third party .

Any content and service provided as it is together with this device shall be the property of the applicable third party, therefore Manufacturer gives no declaration or warranty on modification, suspension, cancellation, termination or abortion thereof, and shall not be held liable for legal actions or indemnity obligation arising thereof.

Manufacturer reserves the rights to restrict the use or access of certain content or service. As the content and service are transmitted through third party's network and transmission facilities, Manufacturer undertakes no customer service thereof or the obligation for such customer service.

【Statement】

- The pictures and instructions in this user manual are for reference only, and may be different from the actual product. Please subject to the actual product. (This statement is throughout this User Manual)
- Quality upgrades, product design and specifications are subject to change without notice.
- The software content service applicable to this product depends on the third party provider, and some software may not be used due to network, region, service cycle and other problems, which has nothing to do with the product quality. Please contact the third party provider for relevant details.



Important Safety Precautions



This symbol alerts user about the presence of a dangerous voltage not isolated inside the product which can be sufficiently powerful to constitute a risk of electrocution.



This symbol alerts user about the presence of important operating instructions and maintenance in the document enclosed in the package.



ATTENTION

RISK OF SHOCK
ELECTRIC



Do not open the back cover.
In no case the user is allowed to operate inside the device.
Only a qualified technician is entitled to operate.



AC voltage: This symbol indicates that the rated voltage marked with the symbol is AC voltage.



DC voltage: This symbol indicates that the rated voltage marked with the symbol is DC voltage.



Class I product: This symbol indicates that it requires a safety connection of protective earthing (ground).

Disposal of Used Electrical & Electronic Equipment



Packaging and electrical goods should be recycled appropriately, and not treated as household waste. Please dispose of this equipment at your applicable collection point for the recycling of electrical & electronic equipment waste. By ensuring the correct disposal of this product, you will help prevent potentially hazardous to the environment and to human health, which could otherwise be caused by unsuitable waste handling of this product. The recycling of materials will help conserve natural resources. Please do not therefore dispose of your old electrical and electronic equipment with your household waste. For more detailed information about recycling of this product, please contact your local city office, your household waste disposal service or the shop where you purchased the product.

Safeguards

Please read the following safeguards for your device and retain for future reference. Always follow all warnings and instructions marked on the device.

1. A note about safety and operating instructions

Read and follow all safety and operating instructions, and retain them safely for future reference.

2. Heed Warnings

Adhere to all warnings on the appliance and in the operating instructions.

3. Cleaning

Unplug the device from the wall outlet before cleaning. Do not use liquid, abrasive, or aerosol cleaners. Cleaners can permanently damage the cabinet and screen. Use a lightly dampened cloth for cleaning.

4. Water and Moisture

Avoid dripping or splashing of liquids onto the product. Objects filled with liquids, such as vases, should not be placed on the product.

5. Ventilation

Slots and openings in the cabinet are provided for ventilation, to ensure reliable operation of the device and to protect it from overheating. Do not cover the ventilation openings in the cabinet and never place the set in a confined space such as built-in cabinet unless proper ventilation is provided. Leave a minimum 10cm gap all around the unit.

6. Power Source

This device should be operated only from the type of power source indicated on the marking label. If you are not sure of the type of power supplied to your home, consult your appliance dealer or local power company.

7. Power-Cord Protection

Power- supply cords should be routed so that they are not likely to be walked on or pinched by items placed upon or against them, paying particular attention to cords at plug, wall outlets, and the point where they exit from the device. MAIN plug is used as the disconnect device, the disconnect device shall remain readily operable.

8. Lightning

For added protection for this device during a lightning storm, or when it is left unattended and unused for long periods of time, unplug it from the wall outlet and disconnect the cable system. This will prevent damage to the device due to lightning or power-line surge.

9. Overloading

Do not overload wall outlets and extension cords as this can result in a risk of fire or electric shock.

10. Object and Liquid Entry

Never push objects of any kind into this device through openings as they may touch dangerous voltage points or short-out parts that could result in fire or electric shock. Never spill liquid of any kind on or into the device.

11. Servicing

Do not attempt to service this device yourself as opening or removing covers may expose you to dangerous voltage or other hazards. Refer all servicing to qualified service personnel.

12. Damage Requiring Service

Unplug the device from the wall outlet and refer servicing to qualified service personnel under the following conditions:

- (a) When the power - supply cord or plug is damaged.
- (b) If liquid has been spilled, or objects have fallen into the device.
- (c) If the device has been exposed to rain or water.
- (d) If the device does not operate normally by following the operating instructions. Adjust only those controls that are covered by the operating instructions as an improper adjustment of other controls may result in damage and will often require extensive work by a qualified technician to restore the device to its normal operation.
- (e) If the device has been dropped or the cabinet has been damaged.
- (f) When the device exhibits a distinct change in performance - this indicates a need for service.

13. Replacement Parts

When replacement parts are required, be sure the service technician has used replacement parts specified by the manufacturer or have the same characteristics as the original part. Unauthorized substitutions may result in fire, electric shock or other hazards.

14. Safety Check

Upon completion of any service or repair to the device, ask the service technician to perform safety checks to determine that the device is in safe operating condition.

15. Heat

The product should be situated away from heat sources such as radiators, heat registers, stoves, or other products (including amplifiers) that produce heat.

16. Fire

The product should be situated away from naked flame sources such as lighted candle.

17. Off-gassing

The device smells of plastic is normal and will dissipate over time.

! Incorrect replacement of the battery may lead to the risk, including the replacement of another similar or the same type. Do not expose batteries to heat such as sun or fire or something like that.

! The device should not be exposed to dripping and spraying and it cannot be placed under objects filled with liquids.

! Main plug is used as the disconnect device, the disconnect device shall remain ready for operating.

! Apparatus with CLASS I construction shall be connected to a MAINS socket outlet with a protective earthing connection.



Start Guide

Precautions for Installation

- As shown in the figure below, leave a ventilation space around the device.

When mounted on the wall:

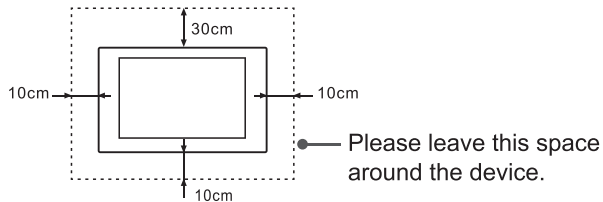

- Do not install the device as shown below.

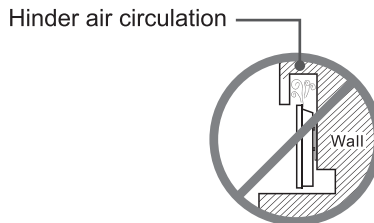

Insufficient ventilation will overheat the device and may cause damage to the device and even fire.



CONTENTS

Contents	1
Accessories List.....	2
Wall Mount (Optional).....	2
Remote Control	4
Control Panel.....	6
Terminal Introduction	7
Initial Startup.....	9
System Menu.....	10
Serial Protocol	11
Miscellaneous.....	14
Specifications	15
EU Declaration of Conformity (DoC)	17
UK Declaration of conformity (DoC).....	18

1

Accessories List

Remote Control × 1 Battery × 2 Power Cord × 1
User Manual of the Device × 1 Logo Bracket × 1 Wall Mount Spacer × 4
RJ45 to RS232 converter cable × 1 Wall Mount Screw × 4
EU Energy Efficiency Label × 1 (Optional) UK Energy Efficiency Label × 1 (Optional)

2

Wall Mount (Optional)

1. Before installing the wall-mount bracket, first place the machine on a secure and clean desktop with soft protective cloth. Confirm that the desktop is solid and reliable since the machine is heavy.
2. Remove the wall-mount screws in the wall-mount holes of the rear shell. (Ignore this step in the absence of wall-mount screws.)
3. To avoid damage of the machine, please install the wall mount strictly in the sequence of rollers, wall-mount bracket and wall-mount screws.
4. Before hanging the machine, please confirm that the wall-mount bracket is installed securely without looseness.

Model	VESA wall mount standard (mm)	Diameter of wall-mount screw (mm)
43BM66AE	400×400	M6

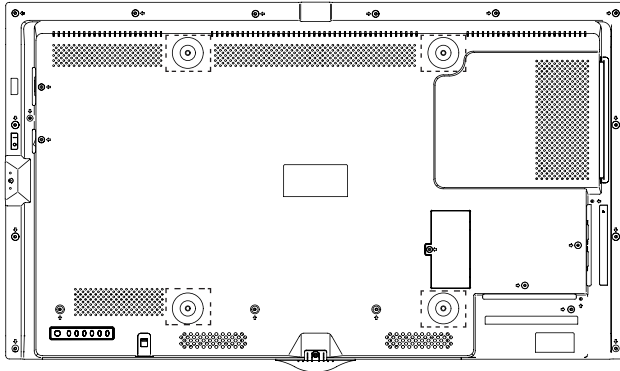

Warning:

- At the four wall-mounting positions shown in the figure, the screw installation depth H should be 6-10mm from the bottom of sunken pit in the rear shell.

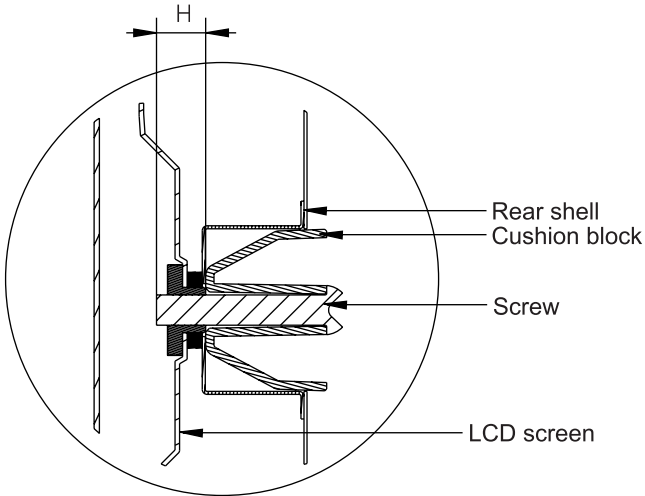

[Note]

- Only the installation specification of the wall mount is described here; the appearance of rear shell is for schematic purpose only.
- The screw installation depth in the wall-mount holes of the rear shell is 6-10mm; overlong screws will cause irreparable damage to the equipment.
- If the intactness of the machine cannot be guaranteed during wall mounting, please contact professional installation personnel or technical support personnel.
- This wall mount is suitable for concrete and brick walls. For plank and plasterboard walls, special reinforcement is required instead of directly using the wall mount. Ensure that a single expansion bolt fixed in the wall can bear over 1/3 of the overall weight of the machine.

3

Remote Control

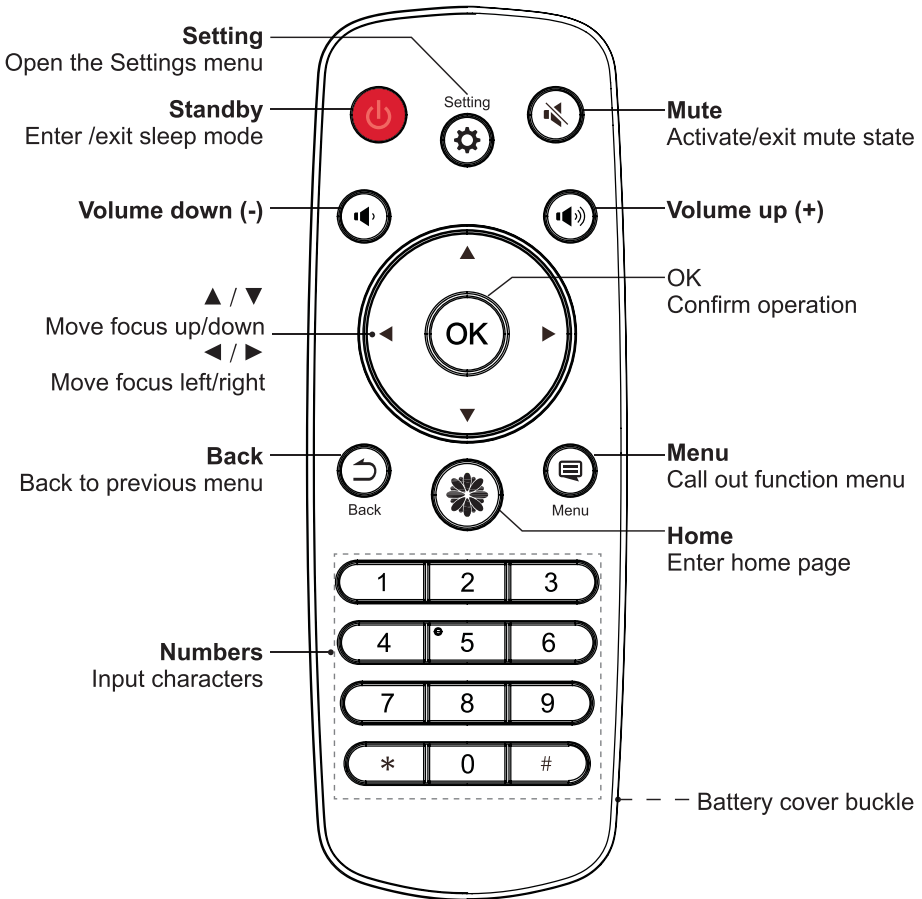

[Note]

- When the remote control is locked, press LEFT>OK>LEFT to unlock it.

Warning: Operation of this equipment in a residential environment could cause radio interference.

Battery replacement method

1. Disconnect the battery cover from the remote control at the battery cover buckle and open the battery cover.
2. Insert two AAA 1.5V alkaline batteries. Note that the positive (+) and negative (-) terminals of the batteries must match the positive (+) and negative (-) terminals in the battery case.
3. Close the battery cover from top to bottom until it is fully aligned with the remote control.

Precautions

1. If the remote control is not working properly, is unstable, or can't control the device, please replace the batteries.
2. If you do not use the remote control for a long time or the battery is exhausted, remove the battery. (Waste battery pollute the environment and must be handled properly.)
3. In order to achieve the best remote control effect, please point the black launch window on the back of the remote control at the indicator light of the device.

Effective range

1. Remote control distance: The distance from the front of the remote control is valid within 8m.
2. Remote control angle: With the remote control receiving window of the device as the apex, the angle in horizontal direction at the distance of 6m is at least $\pm 30^\circ$, and the angle in vertical direction is at least $\pm 15^\circ$.

4

Control Panel

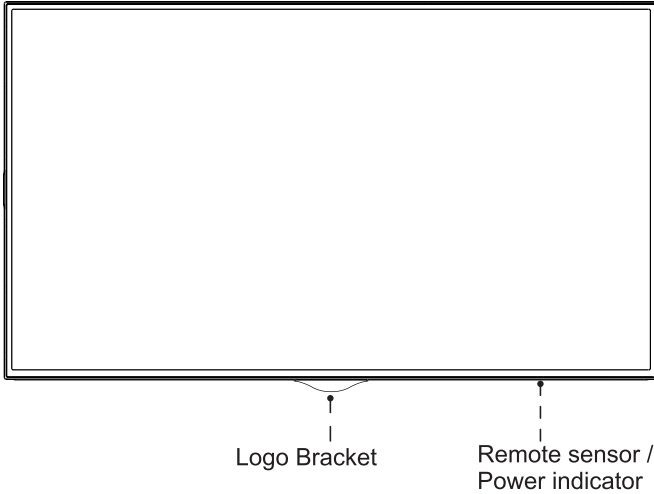

Name/Operation	Function
Remote receiver	Receive signals transmitted by the remote control via this window.
Indicator	When the machine is on, the indicator light is blue; when it enters sleep mode, the indicator light is red.

[Note]

- The appearance is subject to the actual product.
- Since power outage and system processing takes some time, DO NOT power on and off the machine in rapid succession; otherwise the machine may work abnormally.

5

Terminal Introduction

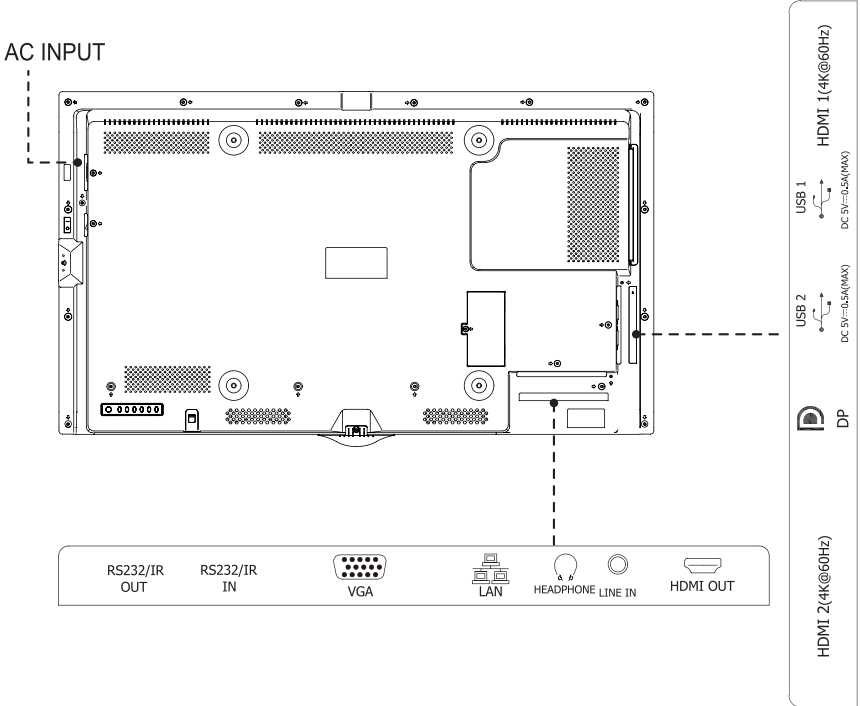

[Note]

- The rear view is for reference only, please subject to the actual product.
- RS232 port: It is for serial communication control of the machine.
- It is possible that some external devices cannot be connected to the machine due to individual difference. In such case, please replace the signal line with a suitable one or add an adapter cable matching the port.

Port Name	Function descriptionunction
HDMI	It can be used to connect an external device with HDMI port, such as STB, player, or PC with HDMI output.
USB	USB standard port is provided with this machine; it can also be used to connect a standard USB device, such as hard disk drive and USB flash drive.
DP	It can be used to connect an external device with DP port.
HDMI OUT	When HDMI2 or DP has signal input, HDMI OUT can output HDMI2 or DP input signals; it can be used to connect other display device with HDMI port.
LINE IN	Input VGA audio analog signals.
HEADPHONE	It can be used to connect a headphone.
LAN	It can be used to connect a network cables so as to access the Internet.
VGA	It can be used to connect a PC or other external device with a VGA port.
RS232/IR IN	It is the input port of the serial communication command, and the port of IR IN.
RS232/IR OUT	It is the output port of the serial communication command, and the port of IR OUT.





[Note]

- The rear view is for reference only, subject to the actual product.
- It is possible that some external devices cannot be connected to the machine due to individual difference. In such case, please replace the signal line with a suitable one or add an adapter cable matching the port.

6

Initial Startup

1 Startup/Shutdown

- Connect the power cord of the machine to a 100-240V AC power outlet.
- Gently press the **power switch**  of the machine toward **I** to turn on the machine.
- In power-on state, press the **STANDBY key**  on the remote control; the machine will enter sleep mode. To watch normally, simply press again the **STANDBY key**  on the remote control.
- To shut down the machine, press the **power switch**  again toward **O**.

[Note]

- After shutdown under AC power supply, there should be an interval of at least 5s before restart to prevent abnormality of the machine.

2 Adjust Local Settings

Use of the setting function can satisfy your different needs and allow you to fully enjoy the audiovisual effect brought by the machine.

You can adjust image and sound, set network connection and perform other operations from here.

- In menus at different levels, you can perform the following operations using the remote control:

Press the **arrow keys** to select each option

Press the **OK key** to confirm operation or enter the sub-menu

Press the **LEFT/RIGHT key** to adjust values

Press the **UP/DOWN key** to adjust options

- Press the **↶ key** to go back to the previous menu.

7

System Menu

1 To open the System menu:

Press the  **SETTING** key to enter the Setting interface, then select the **System** menu.

2 Menu introduction:

- **Time Settings:** Set the local time.
- **Language:** The default language is English. The menu display language can be switched between Chinese and English.
- **Multi Screen Display:** Set the Startup Delay. The range is 0 to 255, 0 indicates no startup delay, and a range of 1 to 255 indicates the delay in seconds. The function of multi screen display can be realized by setting the matching values of splicing rows and columns with the horizontal proportion and vertical proportion. The position are set from left to right and from top to bottom. Set the Edge Masking , and default is off.
- **ID Set:** Set the machine ID between 1~255.
- **Net Start System:** The default state is OFF. When it is OFF, the machine cannot be woken up; when it is ON, the machine can be woken up via network.
- **New Signal Input:** Set the on/off of the new signal input of the machine. When it is On, the machine will automatically switch to the corresponding channel when it detects new signal input.

[Notes] This function is not applicable for some signal sources.

- **Signal Backup:** Main/standby signals can be set. When the main signal does not work, can automatically switch to the standby signal.

8

Serial Protocol

Serial Port State: When the serial port is open, the machine can receive serial port commands sent by the external controller. See the table below for the specific command protocol:

- ① . Baud rate: 9600
- ② . Control part: PC→TV
- ③ . Response part: TV→PC

			Protocol Header		Length	Command Code				BoardID	Data				Check	Protocol End		Remark		
Source Selection	DP	PC to TV	DD	FF	00	07	C1	08	00	00	XX	16					XX	BB	CC	Under Data, the first XX is the equipment number; the second XX is the check digit
		TV to PC	AB	AB	00	07	C1	08	00	00	XX	16					XX	CD	CD	
	VGA	PC to TV	DD	FF	00	07	C1	08	00	00	XX	17					XX	BB	CC	
		TV to PC	AB	AB	00	07	C1	08	00	00	XX	17					XX	CD	CD	
	HDMI1	PC to TV	DD	FF	00	07	C1	08	00	00	XX	0E					XX	BB	CC	
		TV to PC	AB	AB	00	07	C1	08	00	00	XX	0E					XX	CD	CD	
	HDMI2	PC to TV	DD	FF	00	07	C1	08	00	00	XX	0F					XX	BB	CC	
		TV to PC	AB	AB	00	07	C1	08	00	00	XX	0F					XX	CD	CD	
ON/OFF	OFF, PC to TV		DD	FF	00	08	C1	15	00	00	XX	AA	AA				XX	BB	CC	
	TV to PC		AB	AB	00	08	C1	15	00	00	XX	AA	AA				XX	CD	CD	
	ON, PC to TV		DD	FF	00	08	C1	15	00	00	XX	BB	BB				XX	BB	CC	
	TV to PC		AB	AB	00	08	C1	15	00	00	XX	BB	BB				XX	CD	CD	
Mute control	OFF, PC to TV		DD	FF	00	07	C1	26	00	00	XX	00					XX	BB	CC	
	TV to PC		AB	AB	00	07	C1	26	00	00	XX	00					XX	CD	CD	
	ON, PC to TV		DD	FF	00	07	C1	26	00	00	XX	01					XX	BB	CC	
	TV to PC		AB	AB	00	07	C1	26	00	00	XX	01					XX	CD	CD	

Set volume	PC to TV	DD	FF	00	07	C1	27	00	00	XX	XX							XX	BB	CC	Under Data, the first XX is the equipment number; the second XX is the set value of volume; the third XX is the check digit
	TV to PC	AB	AB	00	07	C1	27	00	00	XX	XX							XX	CD	CD	
Query function	PC to TV	DD	FF	00	06	C1	28	00	00	XX								XX	BB	CC	Under Data, the first XX is the equipment number; the second XX is the check digit
	TV to PC	AB	AB	00	0C	C1	28	00	00	XX	XX	XX	XX	XX	XX	XX	XX	XX	XX	CD	CD

[Note]

- BoardID ranges from 01 to FF, supporting networking of 255 machines. 00 is the broadcast address; commands sent from this ID will be executed by all machines but will not be returned.
- For commands received by all TV terminals, when they are returned to PC, the start code should be changed to AB AB and the end code to CD CD.
- Precautions for control terminal programming: For the startup command, after the startup action is executed, AB AB 00 08 C1 15 00 00 XX BB BB XX CD CD will be returned (the meaning of XX is described in the above table); if the startup command is not received, it should be resent. Upon startup of the TV, the PC will receive AB AB 00 08 C1 15 00 00 XX BB BB XX CD CD again, and then it can send a control command to the TV. If no correct command is returned after any command is sent, there should be an interval of over 500ms before resending the command.
- When the TV is in sleep mode, only the startup command and the query command are supported.
- Check digit: XOR values of length, command code, BoardID, data.

9

Miscellaneous

1 Troubleshooting

Before preparation for repair, please check the following table to see if the cause of problem you are encountering can be found.

If the problem still exists when you confirm that you are operating the product in strict accordance with the this manual, you can consider contacting professional service personnel for repair.

Symptom	Solution
No sound or image	<ul style="list-style-type: none">• Check whether the power cord is connected to a wall outlet and whether the outlet is energized.• Check whether the power key is pressed.• Check the volume setting or whether it is muted.
Sound and image interference	<ul style="list-style-type: none">• Try finding out the electrical appliance affecting the machine, and keep it away from the machine.• Try inserting the power plug of the machine to another power outlet.
Blurred or snowy screen, image distortion	<ul style="list-style-type: none">• Check the position and connection of signal line.
Malfunction of remote control	<ul style="list-style-type: none">• Replace the batteries in the remote control.• After removing the batteries, press any key several times, and then install new batteries.• Check the battery contacts.• Check whether any obstruction exists between the display screen and the remote control.• Check whether the anode and cathode of batteries are correctly installed.

2 Related Instructions

HDMI[®] HDMI, HDMI High-Definition Multimedia Interface, and the HDMI Logo are trademarks or registered trademarks of HDMI Licensing Administrator, Inc. in the United States and other countries.

[Statement]

- The pictures and descriptions in this manual are for reference only, please subject to our available products. (This statement is valid throughout this manual)
- Quality upgrade, product design and specification are subject to change without prior notice.
- The software content services applying to this product depend on the third-party provider. It is possible that partial software cannot be used due to network, region, service period or other problems, which has nothing to do with the product quality. Please contact the third-party provider for relevant details.

10

Specifications

Product name		Digital Signage
Model		43BM66AE
Size(mm) (W×H×D)excluding base		968×556×58.5
Weight(kg) excluding base		13.5
Visual picture diagonal size(cm)		108
Power supply		100-240V~50/60Hz 1.5A
Wireless LAN Module specifications	Model	W2NM2510
	Frequency Range	2.4~2.4835GHz
	Output Power(Max.)	2.4~2.4835GHz 17.5dBm
Display resolution		3840×2160
Sound power		9W+9W
Executive standard		Q/0202RSR 615
Environmental conditions		Operating temperature: 0°C~40°C Operating humidity: 10%~80%RH Atmospheric pressure: 86kPa~106kPa

Signal Formats Supported by DP Port

RGB/60Hz	640×480, 800×600, 1024×768, 1280×720, 1280×1024, 1360×768, 1366×768, 1440×900, 1600×900, 1920×1080
YUV/50Hz	576p, 720p, 1080i, 1080p
YUV/60Hz	480p, 720p, 1080i, 1080p
YUV/24Hz 25Hz 30Hz	1080p, 3840×2160

Signal Formats Supported by HDMI Port

RGB/60Hz	640×480, 800×600, 1024×768, 1280×720, 1280×1024, 1360×768, 1366×768, 1440×900, 1600×900, 1920×1080
YUV/50Hz	576i, 576p, 720p, 1080i, 1080p
YUV/60Hz	480i, 480p, 720p, 1080i, 1080p
YUV/24Hz 25Hz 30Hz	1080p, 3840×2160
YUV/24Hz	4096×2160
YUV444/50Hz 60Hz	3840×2160

Computer Signal Formats Supported by VGA Port

Resolution	Refresh Rate	Resolution	Refresh Rate
640×480	60Hz	1360×768	60Hz
800×600	60Hz	1366×768	60Hz
1024×768	60Hz	1440×900	60Hz
1280×720	60Hz	1920×1080	60Hz
1280×1024	60Hz		

The table below lists the supported video formats:

Container Format	Video Decoding				Video Decoding
	Type	Resolution (max.)	Bit rate (max.)	Frame rate (max.)	
.mkv .mp4 .mov	AV1	4096×2160	100Mbps	60fps	Dolby Audio, MPEG1(Layer1,2,3)
.avi .mpg .ts	MPEG2	1920×1080	40Mbps	120fps	Dolby Audio, MPEG1(Layer1,2,3)
.ts .mkv .avi .mp4 .flv	H.264	3840×2160	135Mbps	60fps	Dolby Audio, AAC, MPEG1(Layer1,2,3)
.avi .mpg .mov	MPEG4	1920×1080	40Mbps	120fps	Dolby Audio, MPEG1(Layer1,2,3)
.ts .mkv .mp4	H.265	3840×2160	100Mbps	60fps	Dolby Audio, AAC, MPEG1(Layer1,2,3)

Dolby Audio: Support Dolby Digital and Dolby Digital Plus.

[Note] Since video production tools are nonuniform, it cannot be guaranteed that the machine supports all listed formats.

EU Declaration of Conformity (DoC)

Unique identification of this DoC: hisense-10

We, Declare under our sole responsibility that the product:

Product Name: Digital Signage

Trade Name: Hisense

Model: 43BM66AE

To which this declaration relates is in conformity with the essential requirements and other relevant requirements of the radio equipment directive (2014/53/EU), Ecodesign Directive (2009/125/EC) & Commission Regulation(EU)2019/2021, RoHS Directive (2011/65/EU). The product is in conformity with the following standards and /or other normative documents:

Health & Safety (Art. 3(1)(a)): EN IEC62311:2020
EN62368-1:2014+A11:2017
EMC(Art.3(1)(b)): EN 55032: 2015+A11:2020
EN 55035: 2017+A11:2020
EN IEC 61000-3-2:2019
EN 61000-3-3: 2013+A1:2019
ETSI EN 301 489-1 V2.2.3
ETSI EN 301 489-17 V3.2.4
Spectrum(Art.3(2)): EN300328 V2.2.2
ErP: Transitional Methods - (EU) 2019/2021.
RoHS: EN IEC 63000:2018
Software*: 43.V0000.BM66.AE.00.01W.L0908

*The company reserves the right to install updated Software versions to improve the performance of the appliance.

Place and date of issue (of this DoC): QingDao 2021/09/10

Signed by or for the manufacturer: Hisense Commercial Display Co., Ltd.

Address: No. 218, Qianwangang Road, Economic& Technology Development Zone, Qingdao, China

Title: Product manager

Name (in print): Yangli



EPREL Registration Information

Model identifier	Eprel registration number
43BM66AE	945536

UK Declaration of conformity (DoC)

Unique identification of this DoC: hisense-11

We, Declare under our sole responsibility that the product:

Product Name: Digital Signage

Trade Name: Hisense

Model: 43BM66AE

To which this declaration relates is in conformity with the essential requirements and other relevant requirements of the Radio Equipment Regulations 2017, The Ecodesign for Energy-Related Products Regulations 2010, Ecodesign for Energy-related Products and Energy Information Regulations 2021 (with respect to Ecodesign Requirements for Electronic Displays) & The Restriction of the Use of Certain Hazardous Substances in Electrical and Electronic Equipment Regulations 2012. The product is in conformity with the following standards and /or other normative documents:

Health & Safety (Art. 3(1)(a)): EN IEC62311:2020
EN62368-1:2014+A11:2017
EMC(Art.3(1)(b)): EN 55032: 2015+A11:2020
EN 55035: 2017+A11:2020
EN IEC 61000-3-2:2019
EN 61000-3-3: 2013+A1:2019
ETSI EN 301 489-1 V2.2.3
ETSI EN 301 489-17 V3.2.4
Spectrum(Art.3(2)): EN300328 V2.2.2
ErP: Transitional Methods - (EU) 2019/2021.
RoHS: EN IEC 63000:2018
Software*: 43.V0000.BM66.AE.00.01W.L0908

* The company reserves the right to install updated Software versions to improve the performance of the appliance.

Place and date of issue (of this DoC): QingDao 2021/09/10

Signed by or for the manufacturer: Hisense Commercial Display Co., Ltd.

Address: No. 218, Qianwangang Road, Economic& Technology Development Zone, Qingdao, China

Title: Product manager

Name (in print): Yangli

UK Local Representative
Hisense UK Limited
Unit 2, Meadow Court, Millshaw, Leeds, LS11 8LZ
(+44) 1133 956930
service@hisense.co.uk

