

# Xpress Mobile Screen

## User Manual

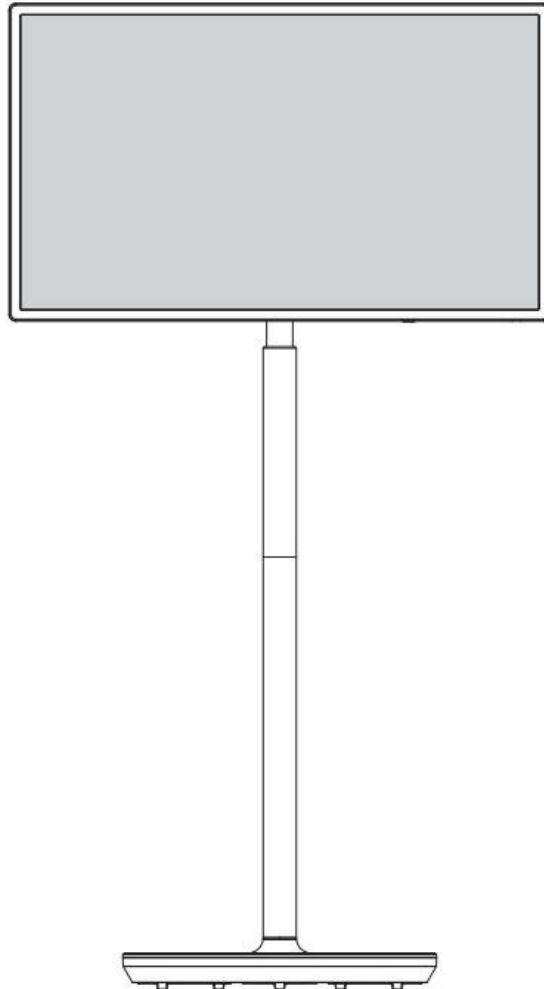

To ensure proper use of the product, please read this User Manual carefully before installation and use. (Please keep this manual properly for future reference) Pictures shown in this User Manual are only schematic diagrams.

# Contents

---

Packing List .....	1
Safety Warnings and Precautions.....	2
Installation Instructions.....	6
Adjustment of Angle and Height.....	9
Connection of Peripherals.....	10
Functions of Keys.....	10
Use of Internal Battery.....	11
Remote Control (Optional).....	12
Basic Operations.....	13
Power-on/Standby.....	13
Touch Operation.....	13
Bluetooth Setting.....	14
Wireless Network Connection.....	14
Cast Function.....	14
Important Statement on Network Service.....	14
Troubleshooting.....	15

# PackingList

---

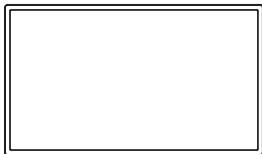

Display screen



Ring decoration strip  
(at back cover of  
display screen)

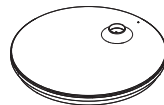

Base

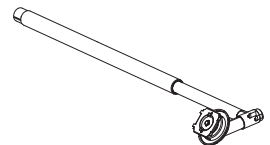

Lifter



Power cord

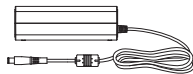

Power adapter



Screws



Remote control  
(optional)

# Safety Warnings and Precautions

---

Congratulations on your purchase of this product. This product is supplied with mecanum wheels which can move freely with you, so it can be used in various environments such as living room, bedroom, office and camping site. The product is integrated with the advanced touch technology, featuring fast response, precise positioning, strong environmental adaptability, accurate operation, etc.

Personal safety factors have been taken into account during design of the product, and the product has been tested strictly before delivery. However, improper installation and use could result in electric shock, fire or other hazards. To ensure its safe use, prolong its service life and bring its best performance into full play, please read and understand all operating instructions and nameplate indications and observe the following safety precautions carefully before using the product, and keep this manual properly for future reference.



**Caution:** In order to reduce the risk of electric shock, please do not remove the cover plate (or back plate). The product does not contain any user-serviceable components. Please consult qualified service personnel for service arrangement.

 There is “dangerous voltage” without insulation protection in the product housing, and the voltage strength is high enough to pose the risk of electric shock.

 <b>Warning</b>	May result in casualties		Indicate the behaviors that must be prohibited
 <b>Caution</b>	May result in personal injury or property losses		Indicate the operations that must be performed

- In any of the following situations, turn off the product immediately, disconnect the power plug from the power socket and contact authorized professional service personnel for repair.
  1. The product produces abnormal sound or smell or has any other obvious abnormality.
  2. The power cord or power plug is damaged or worn.
  3. The product gets damaged due to fall, strike or impact. Any liquid flows or foreign object falls into the product.
- In case of any flammable gas leakage, do not connect/disconnect the power plug of the product or any other electrical appliance but close the leaky valve and open the doors and windows immediately.

# Safety Warnings and Precautions

---

## Warning

- ⊘ ● This product can only use the power supply of the type indicated on its nameplate. If you are not sure about the type of power supply in use, please consult your product dealer or the local power supply bureau.
- The power cord uses a 3-prong plug with ground protection. For the sake of safety, please use a 3-pin outlet with ground protection, and ensure that the ground terminal is well grounded.
- Do not disassemble the adapter or power cord, which may cause fire or electric shock.
- Please place the adapter carefully to avoid drop or impact.
- Impact could cause damage of the product.
- Please place the product on an even ground. Do not place the product at an unstable or inclined position; otherwise, drop and damage or even fire could be caused, further resulting in severe personal injury or death.
- Always use the stand and installation method recommended by the manufacturer.
- Never allow children to climb up the product; otherwise, the product will topple over, resulting in severe injury.
- To avoid the risk of swallow, keep small accessories beyond the reach of children.
- Do not put any fabric or other material between the product and the ground.
- Do not place any article on the product.
- Do not place the product:
  1. in an environment that is too damp, hot, cold or dusty or exposed to direct sunlight;
  2. in an environment where flammable or explosive substances are stored or used;
  3. in an environment where there are combustible or corrosive gases;
  4. in or near a bathroom, kitchen or other working environment with high humidity or with source of heat, steam or oil fume.
- Do not use any damaged or inappropriate power outlet. Keep a good contact between the power plug and the power outlet.
- Protect the power plug and the power outlet against dust and metal attachments.
- Do not damage the power cord:
  1. Do not remodel the power cord;
  2. Do not put heavy objects on the power cord;
  3. Keep the power cord away from heat sources;
  4. Do not pull the power cord when disconnecting the power plug. Please hold the power plug instead of the power cord.
- Paralleling too many power plugs to one power outlet may cause fire due to excessive power consumption.
- To avoid the risk of electric shock or fire, keep the product away from naked flames (like burning candles).

# Safety Warnings and Precautions

---



## Warning

- Do not put any container with water on the product, or water drops or splashes could cause electric shock or fire.
- To avoid the risk of short circuit, product damage and electric shock, do not put any sharp object, metal or liquid into or allow them to contact the ventilation holes or signal connectors.
- The ventilation holes in the housing are designed to protect the internal components against overheat and ensure their long-term reliable work. The product should be placed without blocking such ventilation holes. Always leave a space of at least 4" or 10cm around the product to guarantee good ventilation.
- ⊘ ● The base of the product contains an internal lithium battery. Please take care during use!
  - If the battery leaks, please stop using it immediately to avoid contact with your skin and eyes. Carelessness in this respect could result in loss of eyesight or burn injury. If any part of your body in contact with the leaking liquid shows any abnormality, please wash it with sufficient clean water, and also seek medical advices.
  - Please dispose of the battery correctly. Improper battery disposal could pose the risk of explosion or fire. The guideline for battery disposal varies with the country and region.
  - Do not expose the product (especially the lithium battery) to electricity.
  - Do not expose the product to flame, electric heater or direct sunlight. Otherwise, electric shock, injury or fire could be caused.
  - To charge the battery, do not use any power supply or circuit beyond the specified range. Otherwise, the risk of battery damage or fire will be caused.
  - Be careful when using the lithium battery since the risk of fire or explosion exists.
  - Clean the charging port using a soft cloth. If dirt or other foreign object exists on the charging port, the battery cannot be charged normally, or fire can be caused.
  - If the battery is fully discharged and left unused for a long period of time, it is possible that the battery cannot be charged or that the battery life is shortened.
  - Do not remove, disconnect, disassemble or short-circuit the battery. Otherwise, electric shock, injury or fire could be caused.
  - Do not replace the battery with one of wrong model that could deactivate the safety protection. Using a battery of wrong model poses the risk of explosion.
  - Do not throw the battery into the fire or heating furnace, or mechanically extrude or cut the battery; otherwise, explosion could be caused.
  - Do not place the battery in an environment with extremely high temperature that could result in battery explosion or leakage of flammable liquid or gas.
  - Do not place the battery under extremely low atmospheric pressure that could result in battery explosion or leakage of flammable liquid and gas.

# Safety Warnings and Precautions

---

## Warning

-  To avoid the risk of electric shock, do not touch the power plug with wet hands.
-  Do not use the product during rainstorm or lightning. Disconnect the power plug immediately to protect it against lightning stroke.
-  To avoid the risk of electric shock or fire, do not disassemble the product in any way. All repairs should be referred to professional technicians.

## Caution

- Please tidy the wires and cables connected to the product to avoid trip-over, pull or grab. Please ensure that no juveniles play, disport, chase each other, run or jump around the product, or push, drag, touch or impact the product in any way, thus to avoid topple-over or damage of the product.
- Please ensure that no pets play, disport, run or jump around the product, or push, drag, touch or impact the product in any way, thus to avoid topple-over or damage of the product.
- Do not place the product on a carpet or cushion.
- Take care to protect your hands, feet, hair or clothes from getting stuck in the wheels.
- Do not push or kick the product.
- Do not ride on the product as it was a foot rest.
- Do not use hard objects to rub or strike the screen or twist or press it forcibly.
- Disconnect the power plug before cleaning the product. Clean it with a soft cloth without using any industrial chemical. Take care to prevent the ingress of any foreign object into the product. Improper cleaning (e.g., cleaning solution, water) may cause damage to the appearance, erase the printed information or damage the internal components (if the cleaning solution or water flows into the product) and cause display failure.
- Disconnect all cables before changing the position of the product. To avoid the risk of fall, move the product slowly.
- To avoid the risk of dew and fault, do not use the product immediately after moving it from a low-temperature place to a high-temperature place.
- Please do not place the product near any strong electromagnetic field; otherwise, it will be subjected to electromagnetic interference and get damaged.
- Please do not place the product directly facing an air conditioner; otherwise, dew can be formed on the panel inside the product, further resulting in fault.
- If the leakage splashes onto your skin when the LCD screen is broken, rinse the skin with clean water for 15min and seek medical advices. Grab the four corners and hold the bottom side rather than exert pressure on the front panel when moving the product with hands.

# Safety Warnings and Precautions

---

## Caution

- If the product keeps displaying one image or there is any still text or icon in a moving image during a long time, an “afterimage” will stay on the screen and last long after the product is turned off. Such fault is not covered by the warranty.
- Watch the screen in a healthy way:
  1. Please watch the screen under proper light condition; insufficient light or long continuous use may damage your vision.
  2. Please adjust the volume to protect your hearing from being impaired by excessively high volume.
- Turn off the product and disconnect the power plug before leaving the product unused for a long time for any reason.
- Cut off power supply to the product by pressing the [ON/OFF] button on the base of the product and also disconnecting the power plug.
- The power plug or appliance coupler acting as the make-and-break device should be easy to operate.
- Insert the power plug into the power outlet reliably. A loose connection may cause sparks or fire.
- To better provide services, all technical specifications contained in this manual and on the carton are subject to change without further notice. If there is any difference between this manual and any actual operation, such actual operation shall prevail.

## Installation Instructions

---

### Installation of Base and Lifter

#### Warning

- During assembly, please lock the mount fixing screws since drop of the mount could result in product damage or personal injury.
- Since the product is somewhat heavy, the cooperation of at least two persons is needed during unpacking and installation.
- When assembling the product, do not apply any foreign matter (e.g., oil, lubricating oil) on the screws.
- After installation of the product, do not remove the cable holder and screws.
- During daily use, please grab the middle of the lifter and ensure that the product moves in upright position. Do not tilt the product since the topple-over risk will be caused, further resulting in fault of the product or personal injury.

# Installation Instructions

## Instructions for Installation of Lifter

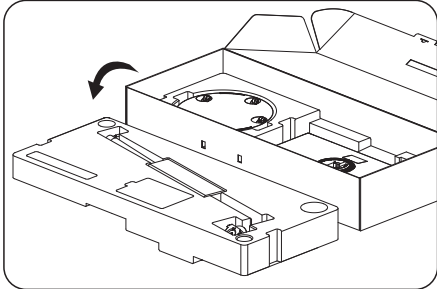

1. After unpacking, take out the expandable polystyrene at the top.

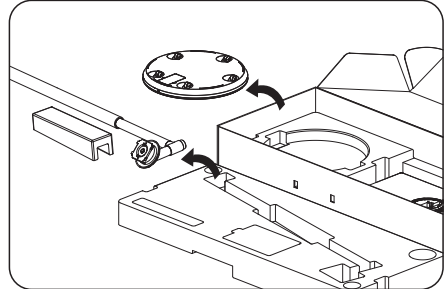

2. Take out the base and the lifter.

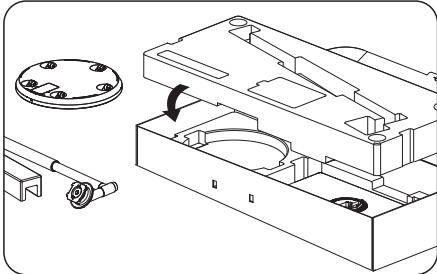

3. Put the expandable polystyrene back to the original position in the package.

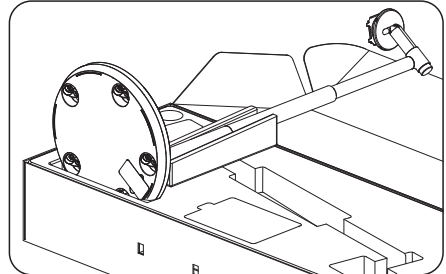

4. Place the base in the slot.

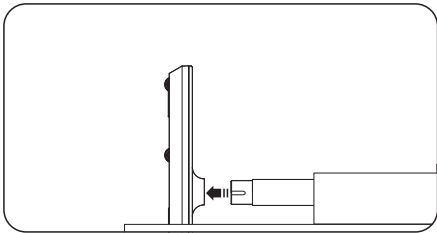

5. Install the lifter to the base by aligning it with the slot position.

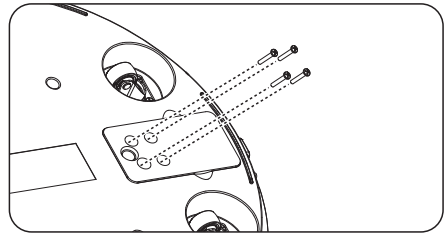

6. Align the screws with the screw holes, and then fasten the screws.



# Installation Instructions

## Instructions for Installation of Display Screen

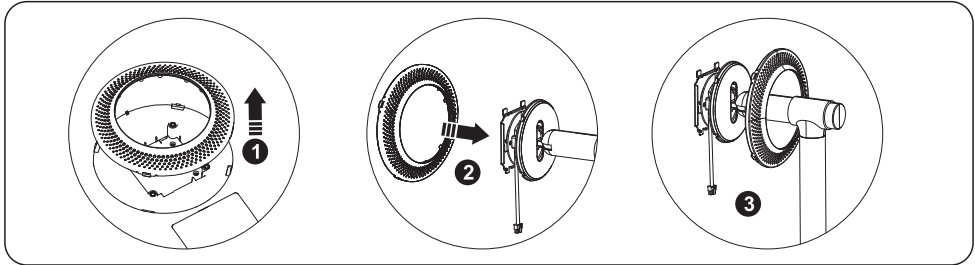

7. Before taking the display screen out of the package, first take out the trim ring at the back; then put the trim ring through the lifter.

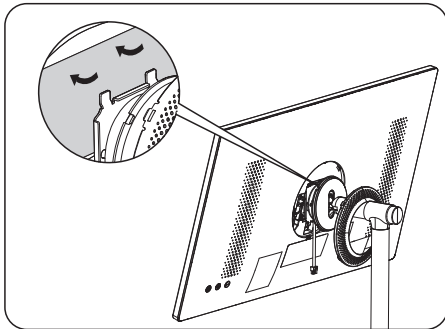

8. Tilt the display screen face up, and install it by alignment with the clipping position.

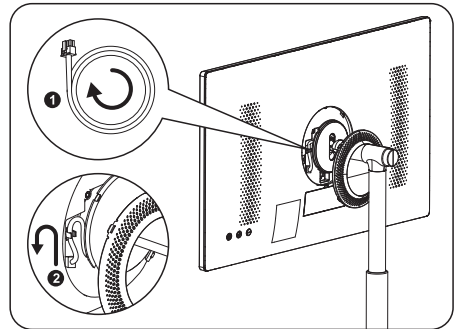

9. Wind the power cord clockwise, and insert the plug; then tidy the power cord and insert it in the fixing slot.

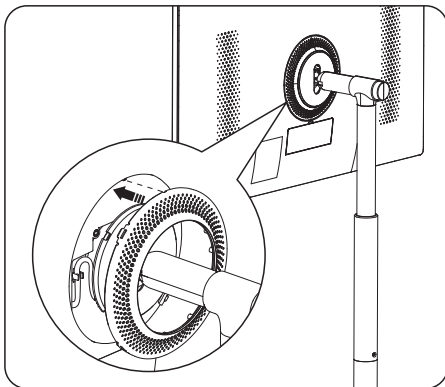

10. Align the locating hole of trim ring with the locating stud on the rear shell of the screen, and simply press to finish installation.

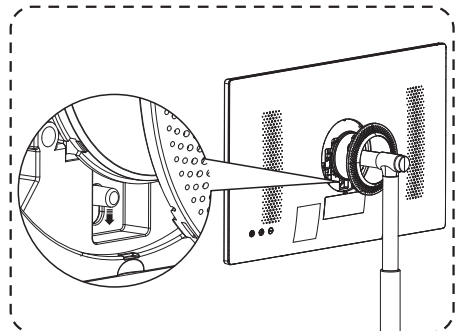

**Attention:** During disassembly, it is needed to press the quick release button to remove the display screen from the lifter.

# Adjustment of Angle and Height

The height and angle of the product can be adjusted to get a comfortable watching experience.

**Attention:** Some applications do not support vertical display.

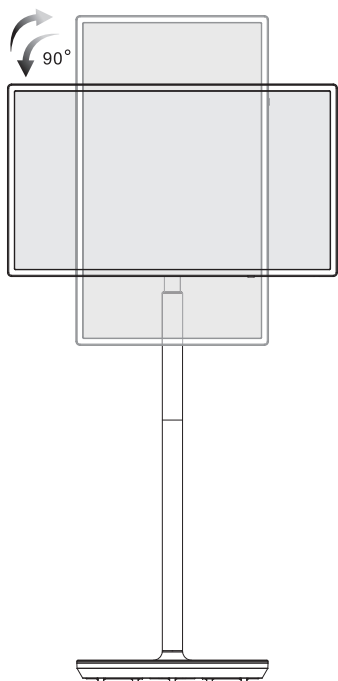

Forward angle:  $20\pm 3^\circ$   
Backward angle:  $20\pm 3^\circ$

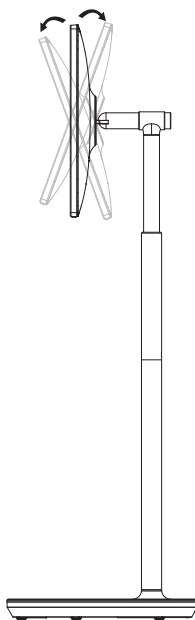

The height of the lifter is adjustable within  $190\pm 10\text{mm}$

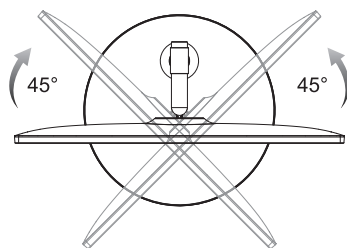
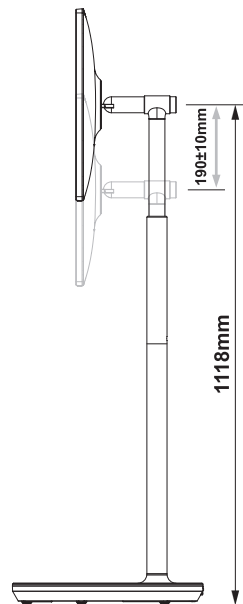

Rotate left/right:  $\pm 45^\circ$

## Caution

- Do not rotate the product at an angle beyond the limit or beyond the maximum adjustable range of height.
- Do not let your hands or fingers get stuck in the stand or height adjustment area.

# Connection of Peripherals

**Warning:** Cut off power supply before connecting/disconnecting any cable.

Open the port dust cover, and connect to the corresponding port as per need.

**TYPE C:** Support 15W reverse fast charge, allowing charging mobile phones, laptops, tablet PCs, etc.; support wired projection (max. resolution: 1920 × 1080@60Hz).

**HDMI:** Connect external devices with HDMI OUT port, including game console, computer, Blu-ray player, HD receiver, DVD player and other external devices.

**USB2.0, USB3.0:** Connect USB storage devices or mouse/ keyboard receivers.

**DC IN (power cord port):** Connect the power adapter.

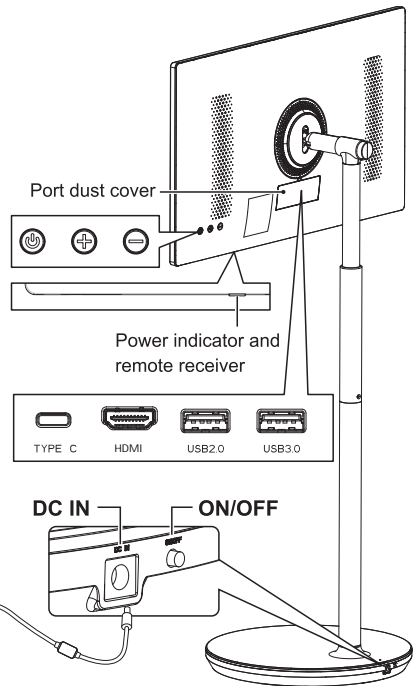

## Attention:

- If it is the first time to turn on the product, please first connect the power adapter so that the product can be turned on normally.
- Please connect the product to the AC-DC power adapter, then insert the power plug of the product to the power outlet.

# Functions of Keys

**ON/OFF:** Turn on or off the product.

⏻ : In standby mode, press ⏻ key to turn on the product. During normal working, press ⏻ key, and the screen will show the auxiliary menus, then you can operate as per need.

+ VOL+: Increase the volume.

- VOL-: Decrease the volume.

## Use of Internal Battery

---

The base of the product contains an internal battery which can supply voltage to the product for some time when no other power supply is connected. The battery indicator light has three different colors (green, yellow and red) which change with the remaining battery capacity. The red light is on during charging or when charging is necessary.

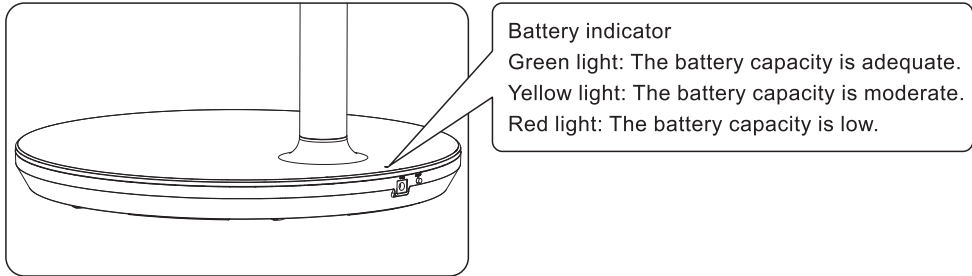

### Attention:

- It takes about 4h to fully charge the battery while using the product, and only 2h in fast charge mode when the product is in power-off state.
- The battery life and service time after charging reduces in proportion to the service period of the product.
- The battery cannot be charged in extreme environments.
- In standby mode, the remaining battery capacity reduces naturally.
- To prolong the battery life, it is suggested to charge the battery after use for some time instead of keeping the battery fully charged.
- Maintaining the battery capacity at 50% helps to prolong the battery life.
- The maximum service time after charging is 3h.
- The service time may vary with various factors, such as connected devices, operating temperature, service period and user settings. Therefore, the actual time may vary with the service condition.



# Remote Control (Optional)

## How to Install Batteries in the Remote Control

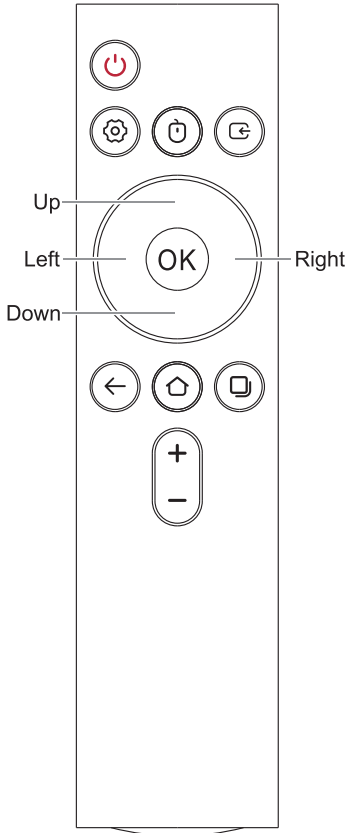
Remove the battery compartment cover; install two AAA (No.7, 1.5V) batteries, and ensure that the terminals of the batteries are consistent with the “+” and “-” symbols in the battery compartment of the remote control.















## Instructions for Pairing Bluetooth Remote Control

1. Click “**Settings > Bluetooth > Remote control pairing tutorial**” on the screen.
2. Simultaneously press and hold the  key and  key on the remote control, and release the keys when the indicator light on the remote control blinks. At this moment, it enters the auto pairing state. Keep a distance of less than 20cm between the remote control and the screen, and wait for the screen to show the pairing successful prompt.
3. If successful pairing cannot be achieved, please retry.

Remark: The device name of the Bluetooth remote control is **Bluetooth remote RC-25**.

## Description of Control Keys on the Remote Control

-  Switch between normal operation and standby mode.
-  Open the control center.
-  Enable or disable the mouse function.
-  Switch the signal source.
-  Press the Up/Down/Left/Right key to select a function.  
 Press the  key to confirm the operation.
-  Go back to the previous menu.
-  Go back to the home page.
-  Show the launched applications.
-  Press + to increase the volume.
-  Press - to decrease the volume.

## Precautions for Use of Remote Control

- Point to the remote receiver when using the remote control. Articles placed between the remote control and the remote receiver may interfere with normal operation.
- Protect the remote control from violent vibration. Besides, do not set or place the remote control under direct sunlight since heat can cause deformation of the remote control.
- When the remote receiver of the main unit is exposed to direct sunlight or strong lighting, the remote control may malfunction. In such case, please change the angle of light or this product, or operate the remote control close to the remote receiver.
- Low battery voltage will affect the remote control distance, in such case, replace the

## Remote Control (Optional)

---



batteries with new ones. If the remote control is to be left unused for a long period of time, or if the batteries run out, please remove the batteries to avoid corrosion of the remote control due to battery leakage which could further result in damage of the remote control.

- Do not use batteries of different types. Avoid mixed use of new and old batteries; always replace the batteries in pair.
- Do not throw the batteries into the fire, or charge or decompose the batteries. Never charge, short-circuit, disassemble, heat or burn any used batteries. Please dispose of waste batteries according to applicable regulations for environmental protection. Do not expose the batteries to sunlight, fire or other environments with excessive heat.

## Basic Operations

---

### Power-on/Standby

Connect the power cord, and press the **[ON/OFF]** key on the base to turn on the product. In power-on state, press the  key on the rear shell, then the screen will show the auxiliary menus. Click , then the product will enter standby. Press **[ON/OFF]** key to turn off the product.

### Touch Operation

- Click: Tap on the screen.
- Click and hold: Tap on the screen for 2s or longer.
- Swipe: Swipe on the screen up, down, left and right.
- Drag: Tap and hold the target (e.g., an application) to be moved, then swipe to the desired position.
- Open/close: Place two fingers on the screen, then open or close these fingers to zoom in or out the content displayed on the screen.

Click **“Settings > Universal > Gesture Navigation Tutorial”** to show the gesture guide in the interface.

#### Attention:

- Whether the displayed content supports the zoom in/out function is related to the application. Please operate according to the actual condition.
- Avoid pressing the screen with force; where necessary, simply use your fingertip to tap on the desired item. If you wear gloves or use your fingernail to touch the screen, it is possible that the product cannot respond and be operated normally.
- If the screen is a little wet or too damp, the sensor cannot work normally when touching it.

# Basic Operations

---

## Bluetooth Setting

Click **“Settings > Bluetooth”**, and turn on Bluetooth; the system will start searching and list the names of Bluetooth devices available nearby. Click the name of device to be connected, and operate according to system prompts. After successful pairing, you can view the corresponding device name in **“Paired Devices”**.

## Wireless Network Connection

Click **“Settings > Wi-Fi”**, and turn on Wi-Fi; the system will start searching and list the wireless network signals available. Click the network to be connected. The  icon beside a network indicates the network is encrypted; the product can be connected to the network only after you enter the correct password.

**Remark:** More system settings can be done under **“Settings”** as per need.

## Cast Function

Click **“Cast”**; select the projection mode according to the device used: Phone/Computer/APP. Perform projection according to different prompts.

**Remark:** Support wired projection via TYPE C port. The connected Type-C device should simultaneously support display (DP Alt Mode), PD charging protocol, and data transmission (USB protocol)

# Important Statement on Network Service

---

All contents and services obtained from the product are owned by third parties and protected by copyright, patent, trademark and/or other intellectual property laws. These contents and services are only for your personal non-commercial purposes, which shall not be used in a way not authorized by the content owner or service provider.

Under no circumstance shall our Company be liable for any direct, indirect or unexpected losses or damages arising from your or any third party's access to any contents or services or any information or third-party software through this product.

Third-party services may be subject to change, removal or discontinuation without prior notice. Our Company does not represent or warrant that some services or contents will remain accessible at any time.

Our Company will not be responsible for any service related to these contents and services, or assume any liability for customer service. For any question or service request about these contents and services, please directly contact your content or service provider.

# Troubleshooting

Symptom	Solution
The screen does not display anything; there is no sound, and the indicator does not turn on.	<ol style="list-style-type: none"> <li>1. Check whether the product has been turned on.</li> <li>2. Check whether the power cord has been connected.</li> </ol>
The product shuts down suddenly.	<ol style="list-style-type: none"> <li>1. It is possible that the internal battery runs out; please connect the power cord.</li> <li>2. Check whether the [ON/OFF] key on the base is in OFF position,</li> <li>3. Check whether the auto shutdown function is activated at the set time point.</li> <li>4. If the battery overheats, the product will shut down automatically for self-protection.</li> </ol>
There is no signal when an external HDMI device is connected.	<ol style="list-style-type: none"> <li>1. Press the [ON/OFF] key to restart the product.</li> <li>2. Reconnect the HDMI cable.</li> <li>3. When the product is on, restart the HDMI device.</li> </ol>
There is no sound.	Adjust the volume to a proper level.
Short remote control distance, malfunction of remote control	<ol style="list-style-type: none"> <li>1. Move the object away to avoid blocking the remote receiver.</li> <li>2. Replace the battery.</li> </ol>
Network cannot be connected	<ol style="list-style-type: none"> <li>1. Ask the network administrator for the available network IP addresses and other parameters.</li> <li>2. Check whether the network cable is connected normally.</li> <li>3. Consult the network service provider.</li> </ol>
The network is very slow when playing videos online	<ol style="list-style-type: none"> <li>1. Please upgrade your network bandwidth to a higher one.</li> <li>2. Please try other VOD addresses to get better resources.</li> </ol>
The product gets stuck, crashes or cannot be operated.	Disconnect the product from power supply; wait for 1-2min and reconnect power supply; then restart the product.